

**A** АДАПТЕР U-HOOK

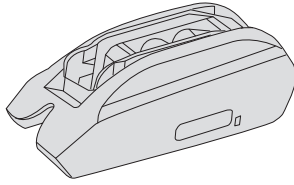

**U-HOOK** [ КРЮЧОК ]

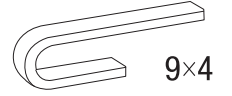
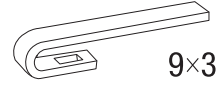

**B** УНИВЕРСАЛЬНАЯ БАЗА

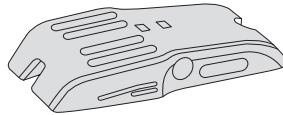
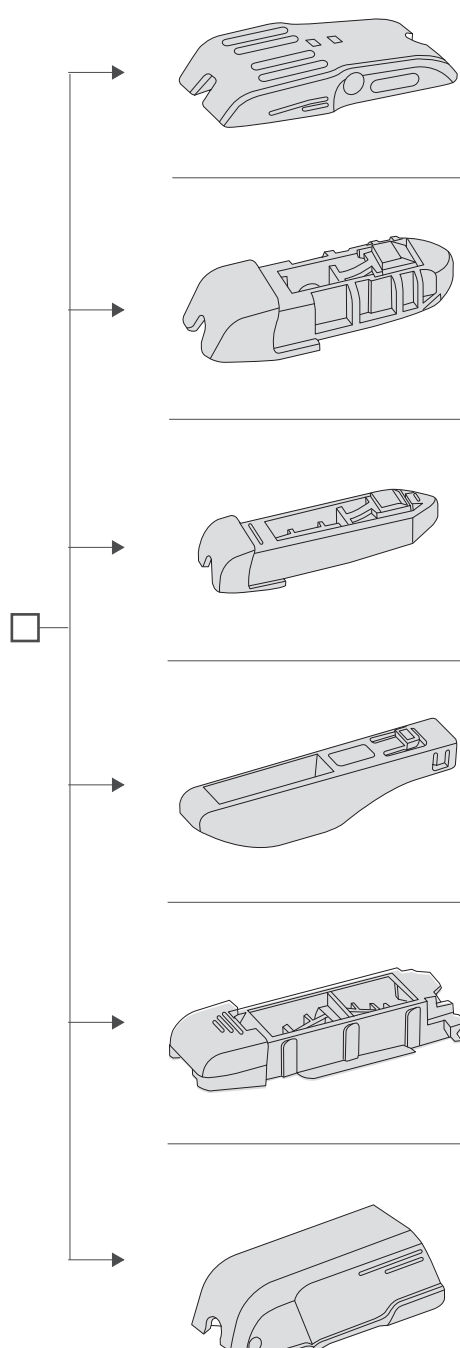
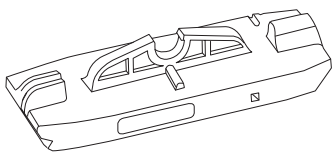

**SIDE PIN** [ БОКОВОЙ ШТЫРЬ ]

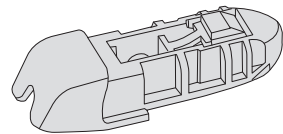
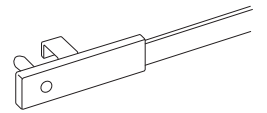
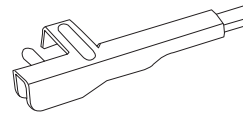

**PUSH BUTTON** [ КНОПКА 19ММ ]  
19ММ

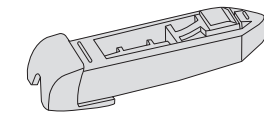
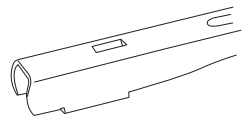
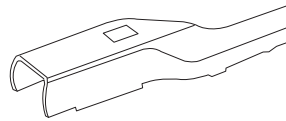

**PUSH BUTTON** [ КНОПКА 16ММ ]  
16ММ

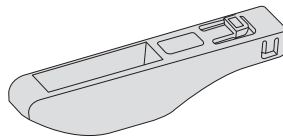
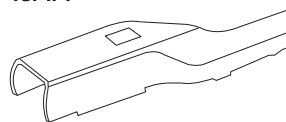

**BAYONET** [ ШТЫК ]

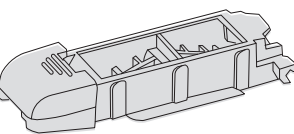
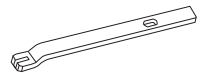

**PINCH TAB**  
[ БОКОВОЙ ЗАЖИМ ]

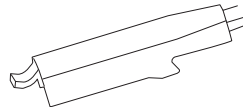

**TOP LOCK**  
[ ВЕРХНИЙ ЗАМОК ]

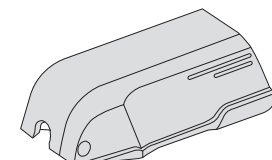
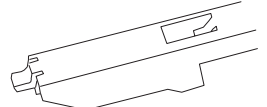

**CLAW** [ КЛЕШНЯ ]

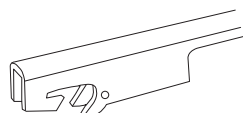

**U-HOOK**

**U-HOOK**

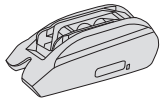
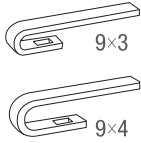

①

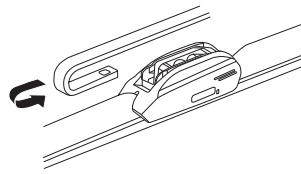

②

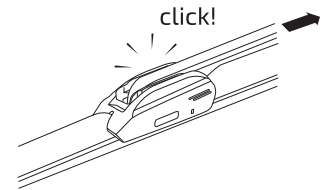

**1 СНИМИТЕ АДАПТЕР U-HOOK**

**ДРУГИЕ**

**УСТАНОВИТЕ УНИВЕРСАЛЬНУЮ БАЗУ**

**2**

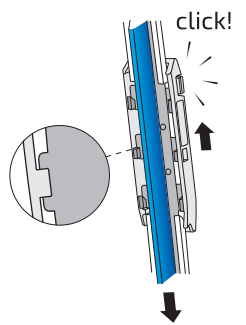
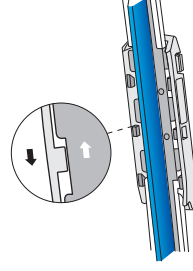
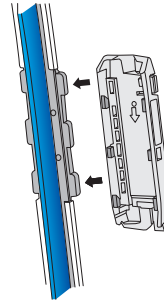
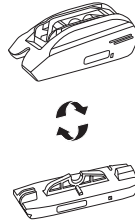
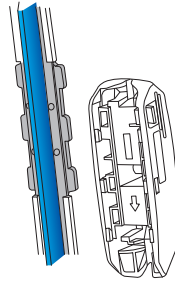
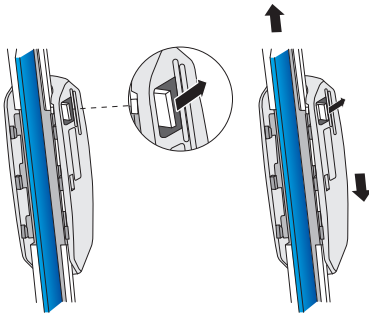

**SIDE PIN**

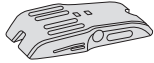
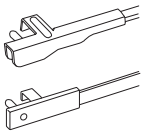

③

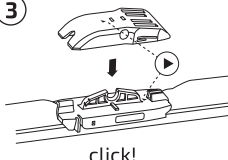

click!

④

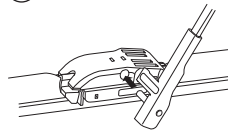

⑤

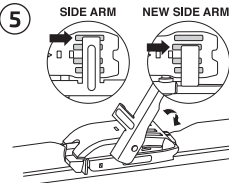

SIDE ARM NEW SIDE ARM

⑥

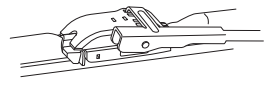

**PUSH BUTTON 19MM**

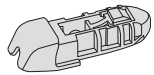
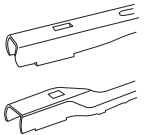

③

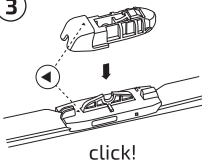

click!

④

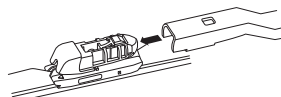

⑤

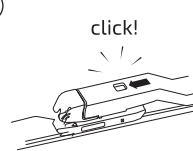

**PUSH BUTTON 16MM**

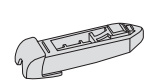
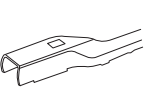

③

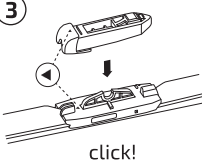

click!

④

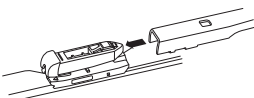

⑤

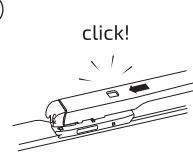

**BAYONET**

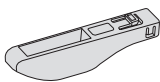
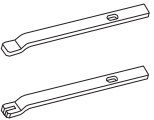

③

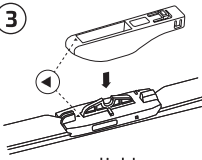

click!

④

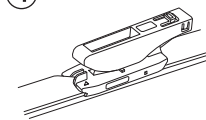

⑤

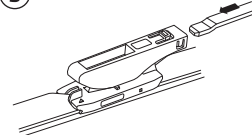

⑥

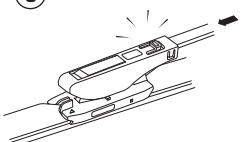

**TOP LOCK**

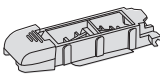
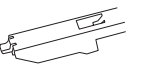

③

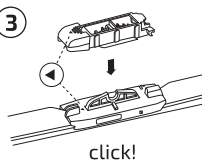

click!

④

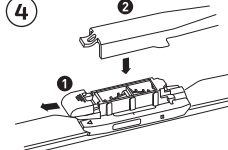

⑤

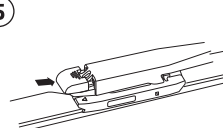

⑥

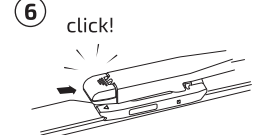

**PINCH TAB**



**CLAW**

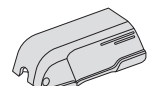
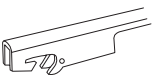

③

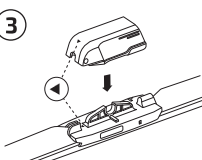

click!

④

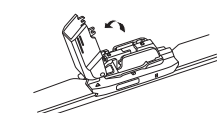

⑤

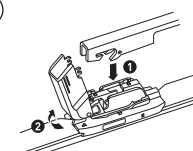

⑥

